

## **DART 16**

# Rigging Manual

- 1 Glossary
- 2 Useful Boat Terminology
- 3 Cordage Lengths
- 4 Sail Number Positioning
- 5 Building the Hull Platform
- 6 Trampoline Fitting
- 7 Rigging & Raising The Mast
- 8 Rigging The Sails
- 9 Gennaker
- 10 Mainsail
- 11 Mainsail Reefing -Dacron Sail only.
- 12 Righting Line
- 13 Rudder Assembly Fitting
- 14 Your First Sail
- 15 Your Dart 16 Capsize Technique
- 16 On The Water
- 17 Safety Afloat

# Dart 16 Rigging Instructions

We suggest that you read through this guide to better familiarize yourself with the parts and rigging of your Dart 16. Due to production supplies, the description, color or specification of certain parts may be different from those shown here. LaserPerformance reserves the right to change specifications without prior notice. If you have any questions about your Dart 16, please contact LaserPerformance.

## Important information

There are four hatches and two transom drain bungs on the Dart 16. They should all be checked for correct fitting and closure every time you sail.

1. The four hatches are located on the top of the hulls. (One hatch behind both the main and rear beam of either hull). (figure 1)



2. The transom drain bungs can be found on each hull next to the lower rudder pintle. (figure 2)



## Example of INCORRECT hatch fitting:

3. Correct fitting of the transom drain bung and the four hatches, is fundamental to the on the water safety and performance of the Dart 16. (figure 3)



## 1. Glossary

- Aft:** Rearward  
**Batten:** A thin stiffening strip in the sail to support the leach  
**Bow:** Front of the boat  
**Burgee:** Wind direction indicator (usually a small flag)  
**Con Bar:** Connecting rod between the rudders to ensure they both move in parallel  
**Cleat:** A fitting used for holding /securing ropes.  
**Clew:** Aft lower corner of a sail  
**Diamond Wires/Spreaders:** Metal struts & wires on mast to support the mast side ways and control bend  
**Downhaul:** Purchase system for tightening the forward edge/luff of the sail  
**Foot:** Bottom edge of the sail  
**Fore:** Forward  
**Forestay:** The wire supporting the mast at the bow of the boat  
**Forestay striker beam:** Triangulated horizontal spreader beam between bows  
**Gennaker:** Asymmetric sail hoisted when sailing downwind  
**Gennaker pole:** Pole used to project the gennaker tack from the bow of the boat  
**Gennaker chute:** Storage compartment for gennaker when not in use  
**Cudgeons/Pintles:** Fittings on the transom and rudder used to hang rudder
- Halyard:** A rope or wire used to lower or hoist sails  
**Head:** Top corner of sail  
**Leach:** Rear edge of the sail  
**Luff:** Forward edge of the sail  
**Main Beam:** Forward beam connecting the two hulls together (the beam the mast sits on)  
**Mast:** Main vertical spar supporting the rig/sails  
**Mast Ball/Step:** Fitting on the boat where the mast heel/foot of the mast is located  
**Mast Heel:** Fitting on the bottom edge/foot of the mast  
**Rear Beam:** Rear beam connecting the two hulls together (The beam the mainsheet traveller track is mounted on)  
**Rudder:** Blade and attachments used for steering the boat  
**Sheet:** Rope for controlling the inward/outward position of the sail  
**Shrouds:** Wires that hold the mast in the boat and support it from 1/3 up and out to hull side; they attach to shroud anchor points  
**Stern:** Back of the boat  
**Tack:** Forward lower corner of sail  
**Trampoline:** Mesh platform strung between hulls of catamaran  
**Tiller Extension:** Extension from the center of the con bar to enable steering from either side of the boat or trapeze

## 2. Useful Boat Terminology

Apply the sail numbers in a dry, clean and wind free environment using the following guidance:

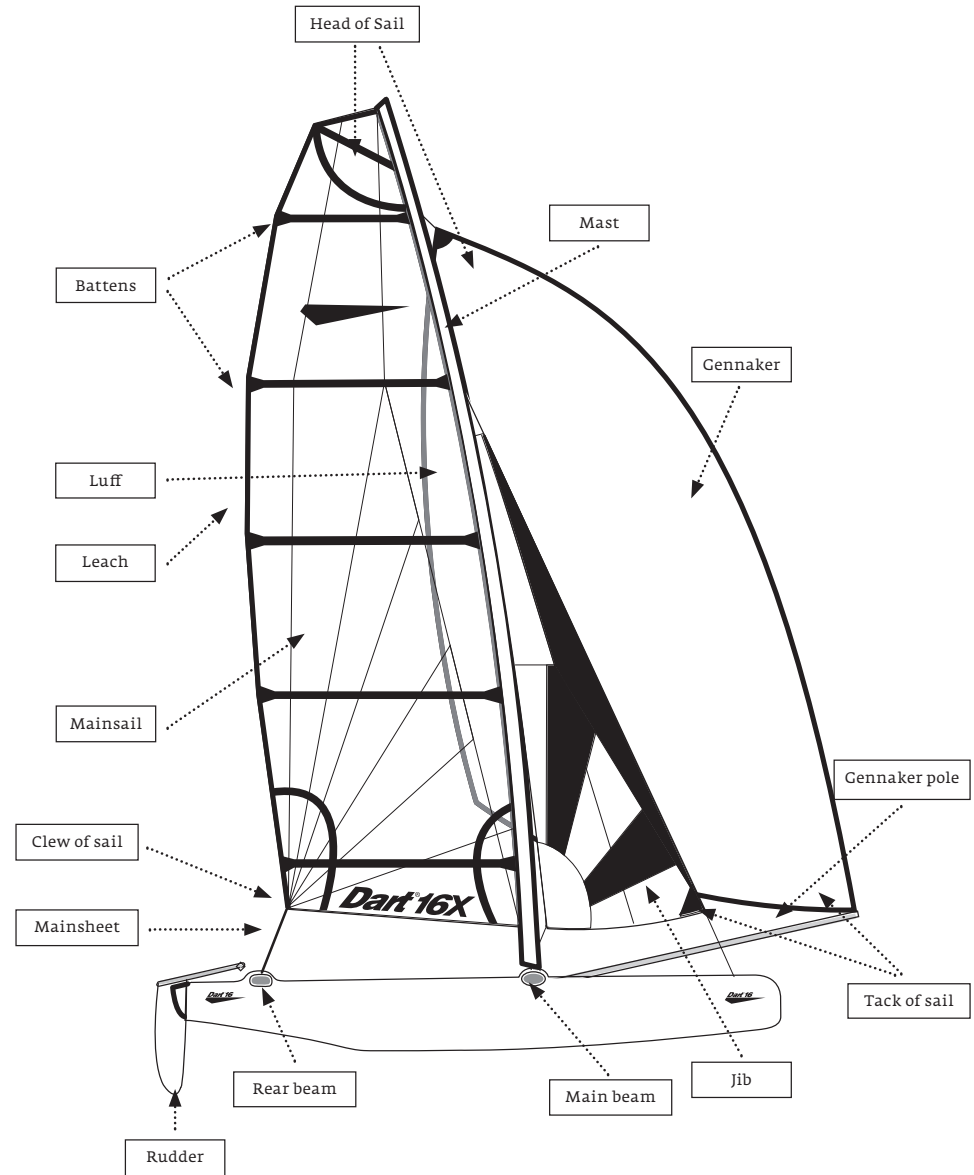

### 3. Cordage Lengths

Item	Diam (mm)	Length (mtrs)	Type of rope	No. per
Gennaker tack line	5	5.6	Dyneema	1
Gennaker halyard	5	17.8	Dyneema	1
Gennaker halyard return	5	0.8	Shockcord	1
Gennaker sheet	6	12.5	Excell lite	1
Gennaker pole outer bridle	5	2.35	Dyneema	2
Gennaker chute mouth rope	3	1.4	Dyneema	1
Gennaker inner bridle	3	1.5	Dyneema	2
Aft tramp line	4	7.3	Dyneema	1
Mid tramp ropes	6	0.6	Multiplatt	2
Tramp corners	3	1.1	Dyneema	4
Main halyard	5	22	Multiplatt	1
Toe strap trim	5	1	Multiplatt	2
Capsize rope	8	5	Flairline	2
Jib sheet	8	16	Platt	2
Traveler rope	8	1.3	Flairline	1
Jib clew	6	1	Multiplatt	1
Trapeze ropes	8	1	Braid on braid	2
Forestay lanyard	4	1.1	Dyneema	1
Furl line	3	3	PST	1
Jib halyard 1	5	4.95	Dyneema	1
Jib halyard 2	2	5.2	Dyneema	1
Jib halyard 3	5	0.5	Shockcord	1

### 4. Sail Number Positioning

1. Lay the sail on a flat surface starboard side up.
2. Numbers on the starboard side of a sail are always higher than those on the port.
3. Mark a parallel line 76 mm above the fourth batten down from the head of the sail.
4. Mark a point on the line 76 mm in from the leach.
5. The first number in the sequence should be positioned on the parallel line you have drawn commencing 76 mm in from the leach.
6. Subsequent numbers should be spaced 60 mm apart.
7. Turn the sail over and position the port numbers 76 mm below the fourth batten down from the head.
8. Work backwards, commencing 76 mm in from the leach.

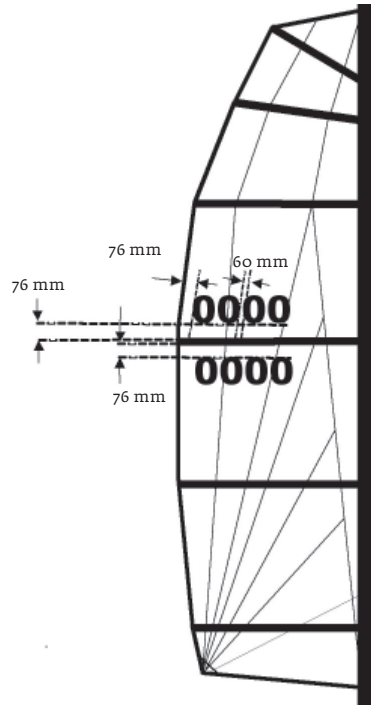

### 5. Building the Hull Platform

#### Tools Required:

- 17 mm spanner
- 8 mm allen key and extension (provided)
- Medium-sized flat & posi screwdrivers
- 2 mm allen key
- 5/6 mm spanner
- Electrical insulation tape
- Grease or copper slip

**Please note:** Ensure that you grease or 'copper slip' the threads of the beam bolts before assembly. The stainless steel threads on the nut and bolt can bind and cease if not lubricated.

To prevent water leaking into the hull through the beam bolts ensure that the o-rings on the rear beam bolts and the neoprene washers on the main beam bolts are placed between the beams and the hull. As an extra precaution you can place silicon sealant around the beam bolt holes before assembly

- When tightening aft bolts place a length of tape over the mainsheet track and on the allen key shaft to prevent damage.
- Post platform build, it is recommended you check bolt tightness periodically.

1. Choose a flat area of at least 6 m x 4 m; you can use the launching trolley to help you line the hulls up. To protect the hulls during assembly you may use the hull plastic packaging. Position the hulls with 1.90 m distance between them. Hulls must be parallel to each other. (figure 1)
2. Place the allen key through the eye of each shroud attachment eye bolt and turn the eye bolt to a 45 degree angle, with the front of the eye pointing towards the mast step/center of the boat. This will hand the hulls port and starboard. (figure 2)
3. Remove the four hatch covers.
4. Identify the beams. The main beam has the ball step and the rear beam, the traveler.
5. Position the front beam flat side facing to the rear; the rear beam high side to the rear.
6. Remove the nuts and washers from the connecting bolts. Leave the rubber o-rings on rear beam bolts and the neoprene washers on main beam bolts.
7. Position the beams in the respective beam pockets. Insert the 8 bolts fully using the allen key. Check the hulls are parallel. (figure 3)
8. Using the hatches, position washer and nut on each bolt. Tighten the bolts progressively using the spanner and allen key. Move around the boat until all bolts are fully tightened. (figure 4)
9. Finally push all beam plugs into the bolt holes. (figure 5)



figure 1

EYE BOLT POSITIONS WHEN FULLY FITTED;

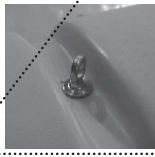
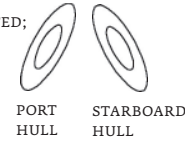

figure 2



figure 3



figure 4

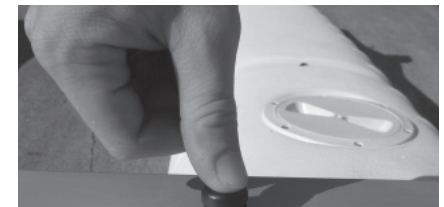

figure 5

## 6. Trampoline Fitting

1. Identify the trampoline direction: halyard bag upwards and near the main beam.
2. Remove external sail slide from the main beam by removing the related screw. (figure 6)
3. Remove one front beam end cap and insert the trampoline into the bottom groove on the main beam. (figure 7)

**Please note:** To prevent damaging the trampoline on the edge of the beam track, the trampoline should be held straight during insertion.

• It is recommended you adjust the trampoline tension periodically.

4. Put the removed sail slide back in place and retighten the screw. (figure 8)
5. Attach the four tramp corner lines to the four external sail slides with a bowline or stopper knot. Lace these lines around the trampoline eyes and sail-slides. Check to ensure the trampoline is well centred. Tie the front corners first so that you have some slack near the front of the trampoline, then tension the rear corners firmly. (figure 9)
6. Take the trampoline aft line and knot it onto the port end of the trampoline tube as shown. (figure 10)
7. Tension the trampoline aft line and thread it progressively round the plastic buttons on the aft face of the rear beam then back around the trampoline tube as shown.
8. Take particular attention to keep the trampoline tube well centered and tie the trampoline aft line back off to the trampoline tube after it is passed round the last plastic button on the far starboard side of the rear beam. (figure 11)
9. Thread the toe strap tramp lines as shown so they form toe strap guides on the upper side of the trampoline and grab handles on the lower side. (Used to steady the boat when righting after capsized). (figure 12)
10. Insert the toe strap sail slides into the upper groove on the main beam on both sides. (figure 13)
11. Pass the respective toe straps through the preferred toe strap guide, then through the respective cut-outs in the skirt at the aft end of the trampoline. (figure 14)
12. Tie the aft end of the respective toe straps off securely to the deck clips positioned on the forward face of the rear beam. (figure 15)
13. To complete the platform assembly, double check all hatch covers, beam end caps and beam fixing plugs are repositioned correctly.



figure 6



figure 7



figure 8

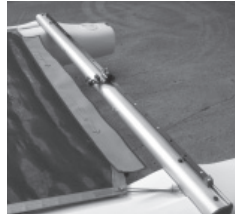

figure 9



figure 10



figure 11

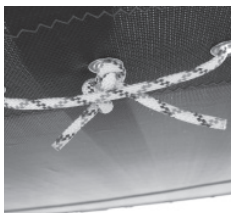

figure 12



figure 13



figure 14

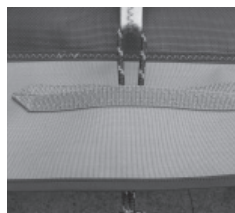

figure 15

**CAUTION:** CONTACT WITH OVERHEAD ELECTRICAL WIRES COULD BE FATAL, EXERCISE EXTREME CAUTION WHEN RAISING THE MAST, LAUNCHING & SAILING.

## 7. Rigging & Raising The Mast

1. Position the blunt face of the striker bar facing forward and attach the forestay striker bar to the respective hull chain plates using the clevis pins and rings provided. (The genacker pole retaining ring should appear on the port side as shown). (figure 16a & 16b)
2. Knot the main halyard with a short bowline on the rear axel at the mast head. Pass the halyard through the mainsail shackle, then over the mast head sheave, down through the mast groove and out through the slit on the mast side and make a stopper knot. This produces a 2:1 purchase system for the main halyard. (figure 17a) (figure 17b)
3. Attach the spreaders onto the mast as shown (Apex of center reinforcing ridge pointing towards the head of the mast). (figure 18)
4. Attach the diamond wires to the dead end fixing terminals riveted on the mast side walls. (You may have to temporarily bend the fixing terminals away from the mast slightly to achieve this.) (figure 19)
5. Locate the diamond wires in the grooves in the outboard end of the spreaders. The diamond wire should be secured to the spreader with rigging wire. (figure 20)
6. Tighten the diamond wires to ensure they are "tight" or 150 kg measured with a loose gauge. (Measured at half height between the spreaders and the lower bottle screws).
7. To tighten the diamond wires you will need a 2 mm allen key to turn the barrel of the bottle screws and a 5 or 6 mm spanner to prevent the turning of the bottle screw unwinding the natural weave composition of the wire. (Hold the spanner static and rotate the bottle screw using the allen key). (figure 21)
8. Finally, check the mast is straight by looking up the mainsail luff groove, if not adjust diamond wires accordingly.



figure 16a



figure 16b

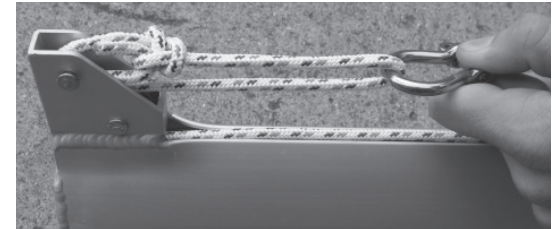

figure 17a



figure 17b



figure 18



figure 19



figure 20

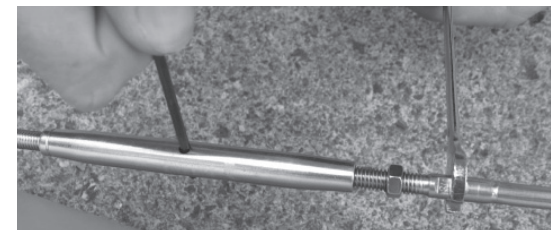

figure 21

9. Thread the gennaker halyard through the bullet block located on the front face of the mast. (figure 22)

10. Insert the standing rigging hound into the track on the front face of the mast as shown. Ensure that the forestay, trapeze wires and shrouds are not tangled. (figure 23)

11. Attach jib halyard and extension as shown. (figure 24)

12. Position the mast onto the boat. While one person lifts the mast at shoulder height, another one should position the mast foot onto its ball support and inserts the pin/axle. (figure 25)

13. Attach the shrouds to the hull chain plates ensuring the adjuster pins are positioned third hole down as shown. (figure 26)

14. Attach the aft trapeze wires to the respective ends of the elastic that pass under and through the side edging tapes of the trampoline. (figure 27)

15. Ensure that the forestay, trapeze and shrouds are not tangled.

**Please note:** Prior to raising the mast, please ensure:

- All halyards are led to the foot of the mast ready to facilitate hoisting of sails.
- All clevis pins, rings and spreader ends are thoroughly encapsulated with amalgamating or electrical insulation tape. (This prevents snags to the sail and derigging from occurring while sailing).
- When attaching the forestay, make sure you get the shackle pin through the jib furling gear and not through the outer guide only or the mast will fall down.
- Shrouds must not be loose before going afloat; there is a risk the mast could jump off the ball step in waves.
- It is recommended to check the rigging tension after two or three sails.

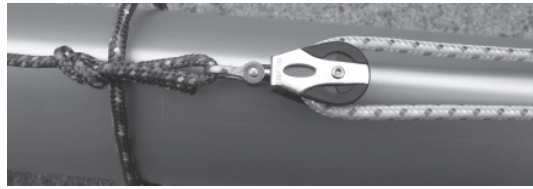

figure 22



figure 23



figure 24

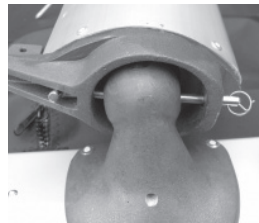

figure 25



figure 26

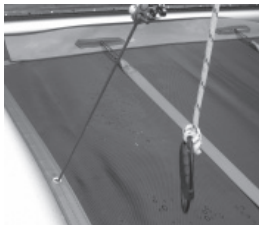

figure 27

16. To raise the mast one person should pull the two forward trapeze handles whilst another stands on the trampoline and raises the mast to its upright position. (figure 28)

17. Hold the mast with the trapeze wires until the forestay lacing is tied securely by lacing the forestay onto the jib furler clevis pin (three loops minimum).

18. Remove the mast foot pin/axle to allow the mast to turn freely, before re-tensioning the forestay lacing firmly.

19. Ensure none of the rigging is tangled then attach the forward trapeze wires to the respective front beam shockcords

20. Pass the jib furler line through the cam cleat on the starboard side of the front beam. (figure 29)

21. Attach the downhaul system to the tang on the aft edge of the mast foot. (figure 30)

## 8. Rigging The Sails: Jib

1. Attach the jib clew strop to the jib clew and attach the two jib clew blocks to each end with a bowline. (figure 31)

2. Attach and thread the jib sheets as shown. The jib ratchet blocks' cleating position can be adjusted.

3. Attach the jib to the forestay by twisting the jib hanks onto the forestay. (figure 32)

4. Tie the jib halyard to the head of the jib using the thin rope hoist the jib.

5. Attach the jib tack to the furler with the jib tack hook. (figure 32)

6. Tension the jib luff by pulling on the thick part of the jib halyard. Do not over-tension it beyond the tension of the forestay.

7. The halyard will automatically cleat in the cam cleat at the hounds.

8. Remove the thin halyard and store it in the halyard bag.

9. Attach the jib halyard retaining shockcord and englefield clip to the furling drum pin with a bowline.

10. Attach the thick halyard clip onto the shock cord clip; you may furl the jib until launched. (figure 33)



figure 28



figure 29



figure 30



figure 31



figure 32



figure 33

**Please note:** To lower the jib, reattach thin part of the halyard. Pass the halyard behind the shroud and back to the bow. Pull the halyard to unlock it from the cam cleat.

## 9. Gennaker

1. Attach the auto ratchet blocks to the respective shroud anchor points using the long D shackles. Please note that this is designed to be a tight fit. (figure 34)

2. Pass the gennaker pole through the retaining ring on the port side of the striker bar and place the pin into the mast foot fitting as shown. (figure 35)

3. Unscrew the plastic button fitting on the end of the gennaker pole and slide the jubilee clip and gennaker chute on to the pole. Replace the plastic button fitting as shown. (figure 36)

4. Find the point where the gennaker chute mouth sits with the aft edge of the mesh bag finishing approximately 100 mm in front of the main beam and tighten jubilee clip with the screw hidden under the pole. (figure 37)

5. Tie the gennaker chute line to the port hull as shown. (figure 38)

6. Lace the aft end of the gennaker chute bag through the "P" clip riveted on the front face of the main beam and around the mast ball neck as shown.

7. Thread the gennaker tack line through the cam cleat positioned on the port side of the mast ball and tie a double stopper knot at the end of the line. (figure 39)

8. Tie the forward pole brace lines from the end of the gennaker pole to the forestay chain plates at the front of both hulls. These lines should be tight inducing approximately 50-75 mm of negative prebend in the gennaker pole. (figures 40 & 41)

9. Tie the middle pole brace lines from the pole just aft of the retaining ring to the forestay chain plates at the front of both hulls. These lines should be tight inducing approximately 50-75 mm of negative prebend in the gennaker pole. (figure 42)



figure 34

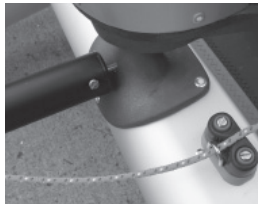

figure 35



figure 36



figure 37



figure 38



figure 39



figure 40



figure 41



figure 42

10. Using a bowline, tie the corner of the gennaker marked "tack" to the tack line exiting from the front of the gennaker pole. Ensure there is a double stopper knot tied in the tack line approximately 50 mm prior to your bowline to ensure the gennaker flies cleanly without the sail fouling the end of the pole. (figure 43)

11. Tie the up haul end of the gennaker halyard to the head of the gennaker using a bowline. (figure 44)

12. As depicted by the diagram: Thread the downhaul end of the gennaker halyard through the uphaul cam cleat (positioned on the front beam on the port side of the tack line cleat), round the gennaker downhaul turning block (tied on a piece of elastic to the port toe strap aft mounting), through the hole in the aft end gennaker chute sock, finally exiting through the gennaker chute mouth.

13. Pass the downhaul through the lower downhaul patch ring traveling in a vertical direction toward the upper downhaul patch. (figure 45)

14. Tie the downhaul off to the upper downhaul patch using a bow line. (figure 46)



figure 43



figure 44

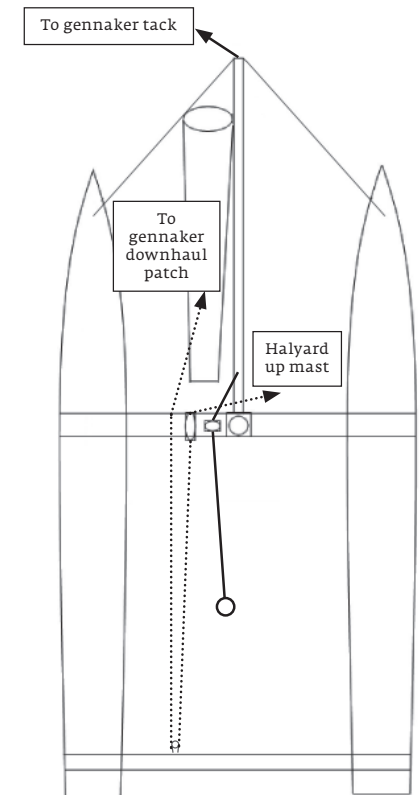

figure 45

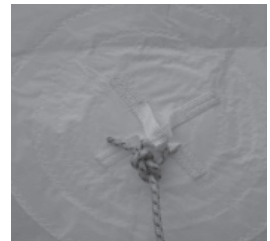

figure 46

15. Tie the gennaker sheet to the gennaker clew by finding the center of the sheet, passing it through the clew of the gennaker, then passing the two tail ends of the sheet through the loop that is formed. (figure 47)

16. As depicted by the diagram: Thread the respective gennaker sheet tails through the blocks and knot the two ends together between the gennaker sheet ratchet blocks attached to either shroud anchor points.

17. To store the gennaker until use: Uncleat the gennaker uphaul and tack line then pull the downhaul rope from the aft end of the gennaker chute sock until the sail is completely stowed.



figure 47

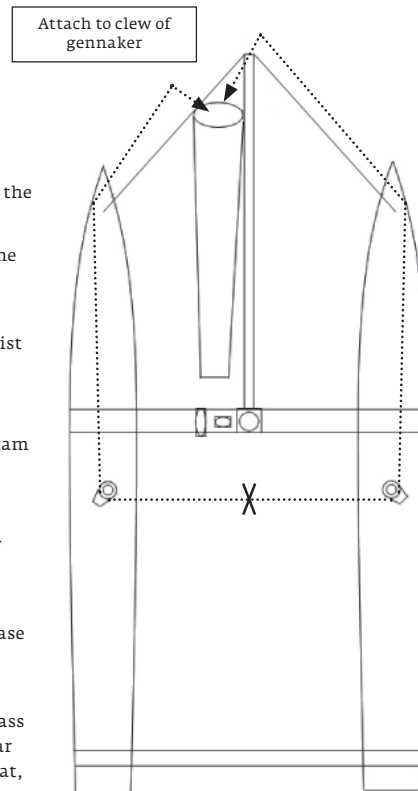

## 10. Mainsail

1. Make sure all battens are firmly fixed in place using the tensioning system at the aft end of the pockets.

2. Place your Dart 16 facing into the wind and attach the mainsail halyard to the head of the sail checking the halyard is not twisted.

3. Insert the sail head into the mast luff groove and hoist the sail by pulling the end of the main halyard.

4. Guide the sail into the groove to help the hoisting.

5. When the sail is fully up, lock the halyard into the cam cleat on the starboard lower rear face of the mast.

6. Store the halyard in the halyard bag.

7. The lower sail slide should be inserted into the lower luff groove (below the sail feeder) and the downhaul system hooked onto the tack eye.

8. Shackle the lower assembly of the mainsheet purchase system on to the mainsheet traveler car and hook the upper assembly onto the clew of the mainsail.

9. Tie a double stopper knot in the traveler rope then pass it through firstly the deck clip on the aft face of the rear beam then through the mainsheet traveler car and cleat, before tying it to the loose end of the mainsheet. This creates an endless mainsheet and traveler car system.

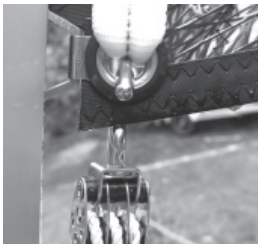

## 11. Mainsail reefing – Dacron Sail only.

1. Lower the mainsail so that the reefing cringle is just above the sail feed area of the mast.

2. Unhook the mainsheet assembly from the clew. Roll the sail around the lower batten and parallel to the reefing eye.

3. Pass the hooks on the reefing elastic around the rolled part of the mainsail and hook them onto the elastic on the other side.

4. Hook the mainsheet assembly onto the clew.

## 12. Righting line

Must be on board and tied round the mast ball neck at all times.

The tail end of the righting line should be coiled neatly and stored in the halyard bag on the trampoline ready for deployment.

## 13. Rudder Assembly Fitting

1. Identify the port and starboard rudders. (Tiller arms bent inwards when mounted).

2. Hang the rudder assemblies on respective transom pintles and gudgeons.

3. Attach circlips through hole in the lower part of respective rudder pintles. (Stops the rudders coming off in the event of capsize).

4. Ensure the retaining clips are located over the lower part of the stock. (Stops the rudders coming off in the event of capsize).

5. Assemble the connecting bar and extension using flexible joints. (Make sure the joint covers are well clicked in to prevent disengagement while sailing).



## 14. Your First Sail

Your boat is now ready to sail, but before you launch it is a good idea to familiarize yourself with the boat's equipment, the technique of lifting and lowering the rudders, and the correct capsize recovery technique.

## 15. Your Dart 16 Capsize Technique

The use of a LaserPerformance supplied Dart 16 mast head float is highly advisable. (*This device will assist in the prevention of complete inversion in the event of capsize*) When sailing your Dart 16 in breezy or blustery conditions, it is highly probable that from time to time you will capsize. In the event of a capsize we advise you follow the procedure documented below:

Righting the Boat:

1. Ensure all members of the crew are accounted for and safe.
2. If the gennaker is deployed, drop the sail back in to the sock.
3. Release the main/jib sheets from respective cleats and ensure the sheets are fully extended to avoid the boat sailing immediately after righting.
4. If the boat inverts, first recover the boat on to its side.
5. In adverse conditions and with more than two crew it is recommended that the largest crew member swim to the bow and hold the bow during righting and until all other crew members have re-boarded after righting. (This ensures the boat swings in to the safe head into wind position upon righting)
6. It is recommended to use the “scoop” recovery system for crewmembers not involved in the righting procedure. When the boat is on its side, the crew members to be scooped should move to the inner lower side of the boat as close to the center of the boat as possible. As the boat is righted, these crew members will be “scooped” onboard the boat ready to help other reboard. “Scooping” should only be attempted with practice and should only be commenced after the boat is stabilized on its side by a crewmember who is securely located on the centerboard and holding the capsizing righting line under the gunwale. This is to prevent the boat from inverting and potentially trapping the crew.
7. To right the boat, one crewmember should stand on the centerboard moving out towards the end of the board whilst leaning out holding on to the righting line. The boat will recover to the upright position quickly. It should normally only require one average size person to effect righting on the centerboard.
8. Immediately after righting, the tiller should be pushed fully towards the mainsail to stop the boat sailing until all crew have reboarded.
9. Re-boarding can be undertaken over the windward side of the boat using the righting line as a step or over the transom. A grab rail is positioned on the inner face of the sub deck to assist with pulling yourself back in to the boat.
10. If the person in charge of the boat or the crew are inexperienced in capsizing and righting procedures, it is advised to perform practice drills under skilled supervision before sailing the boat in earnest.
11. All crewmembers should wear an approved buoyancy aid at all times whilst on the water.

**Warning!** During a capsize, do not hold onto the tiller extension because it will break.

**Warning!** Be careful that you do not get a leg trapped under the toe strap during a capsize or when the hull is heeled.

## 16. On The Water

- Conform to the sailing rules of the road.
- Look out for changing weather conditions.
- Never sail beyond your ability or that of your crew.
- Inform someone of where you are going and when you’ll be back.
- Be competent in your sailing skills and righting techniques

## 17. Safety Afloat

This instruction manual is not a guide to sailing your craft and it should not be considered suitable for the task of learning to sail a boat. Please read the manual before rigging and sailing your Dart 16.

### Before You Go Sailing:

1. Check you are wearing suitable clothing and safety equipment for the conditions and time of year.
2. Always wear a buoyancy aid or life jacket
3. Make sure a third party knows where you are sailing and how many there are of you.
4. Check the weather forecast
5. Check the time of high and low tides if applicable.
6. Seek advice on the local conditions if you are sailing in a new area.
7. Always check the condition of your craft before setting off.
8. **Check for overhead cables when rigging, launching and recovering.**

## Care, Maintenance and Service of your LaserPerformance Product

Before rigging your Dart 16, please read and familiarize yourself with this rigging manual. Failure to adhere to these guidelines could invalidate your warranty.

### Maintenance

- Keep the equipment clean by frequently flushing with fresh water. In corrosive atmospheres, stainless parts may show discoloration/brown staining around screw holes and rivets. This is not serious and can be removed with a fine abrasive.
- Excess water should be removed from the hull.
- Ropes, rigging and fittings should be checked at regular intervals for wear and tear, including winch gear.
- All moving parts should be lightly lubricated to avoid jamming, i.e., McLube, dry Teflon or a dry silicone based spray. Do not use oil.
- Inspect shackles, pins and clevis rings and tape up to stop snagging sails, ropes and clothing and to prevent them from coming undone.
- When refastening screws do not over tighten as this may strip the thread and do not reuse Nyloc nuts more than three times.
- Damaged or worn parts should be replaced.
- Sails should be thoroughly washed down with fresh water, dried and stored in a dry place.

### Trailers and Trolleys/Dollies

- It is highly recommended that a trolley/dolly is used to launch and recover your boat. Dragging your hull up onto a beach or slip way will wear away the gel coat or polyethylene and damage the boat. Also, the hull should not be left on a pebble beach as the hull skin could be dented.
- Trailers should be rinsed with fresh water and checked at regular intervals. It is recommended that trailers be serviced annually. The trailer and road base should never be immersed in water.
- Trailers and trolleys supplied by LaserPerformance are designed to transport the hull in the best possible manner to avoid damaging the hull. For instance, LaserPerformance does not recommend support hulls on rollers except on the keel line and only where there is a reinforced keelson. We also recommend gunwale hung trolleys for our smaller products. Hulls supported by a trolley bunk or wide strap must have the ability to drain water away from the hull. Trolley bunks padded with carpet or foam can cause blistering in the gel coat and changes to the hull color. Please do not transport your LaserPerformance product on a trailer or trolley that has not been specifically designed for the product. Hulls damaged through using an incorrectly designed or wrongly set up trailer or trolley are not covered under warranty.
- When securing your boat to a trailer for transport be very careful that ratchet straps and ropes are not over tightened and that there is sufficient padding under the strap or rope to prevent the hull/deck from being damaged through abrasion or pressure.
- Top covers must not be allowed to “flap” when driving at speed. This can abrade the surface of the hull and damage it. It is recommended if you are towing and plan to use your top cover that an under cover is fitted first to prevent cover flap damage to the top sides of the hull.
- Repairs to the polyethylene or GRP hulls should be undertaken by persons with the relevant equipment and skills. Contact LaserPerformance for advice.

### Storage

- Your boat should always be tied down securely to the ground when not in use.
- UV light will cause fading to some components and fittings. A cover is recommended to reduce the UV degradation.
- Do not leave the rig under tension when not sailing or during storage.
- Care must be taken to support the hull adequately if storing on racking or similar. Any sustained point loading could permanently dent or distort the hull.
- Under covers for LaserPerformance products should be produced from a breathable or semi breathable fabric to allow moisture to evaporate away from the hull. This is essential to prevent damage to the hull skin. Also, the hull should never be left in the under cover wet or damp. A combination of moisture and heat over an extended period can also damage the hull. The under cover is designed to protect the hull when being transported and should be removed when the hull is being stored. Typical damage includes small bubbles or blisters, excessive print through of glass reinforcement, foam or wood and color change.
- Rudders and centerboards must never be stored wet in carry/combo bags. This can cause blistering, print through and warpage.
- All our GRP products are designed to be dry sailed. In other words stored on dry land. If you intend to leave your boat on a mooring for any length of time it is essential that you apply an osmosis barrier coat. LaserPerformance can recommend a suitable product.

### On Water

- When wearing a trapeze harness, take particular care when climbing on to the centerboard and back into the boat after a capsize. The trapeze harness hook could easily damage the hull or deck.

### On Water Towing

- Towing your LaserPerformance product at high speed (10 – 20 knots) behind a rib or power boat can seriously damage the hull. Boats damaged in this manner are not covered by the warranty. LaserPerformance recommends a maximum towing speed of 6 knots.





